

## Metering pumps

The highest reliability system metering pump



Metering pumps

Iwaki metering pumps AX series are compact hydraulic diaphragm pumps designed to meet the exacting requirements of modern advanced chemical processes.



# The highest reliability system metering

Iwaki metering pumps AX series are compact hydraulic diaphragm pumps designed to meet the exacting requirements of modern advanced chemical processes.

The light, compact body incorporates a highly reliable driving unit and unique hydraulic system to assure high, stable performance over long-term continuous operation.

In addition, the new-type servo system with built-in positioner and numerous accessories, are standardized to meet the most stringent service demands of chemical liquid feeding processes, making the AX series suitable for wide application not only in the chemical industry but in many other fields such as paper, food, and waste-water treatment.

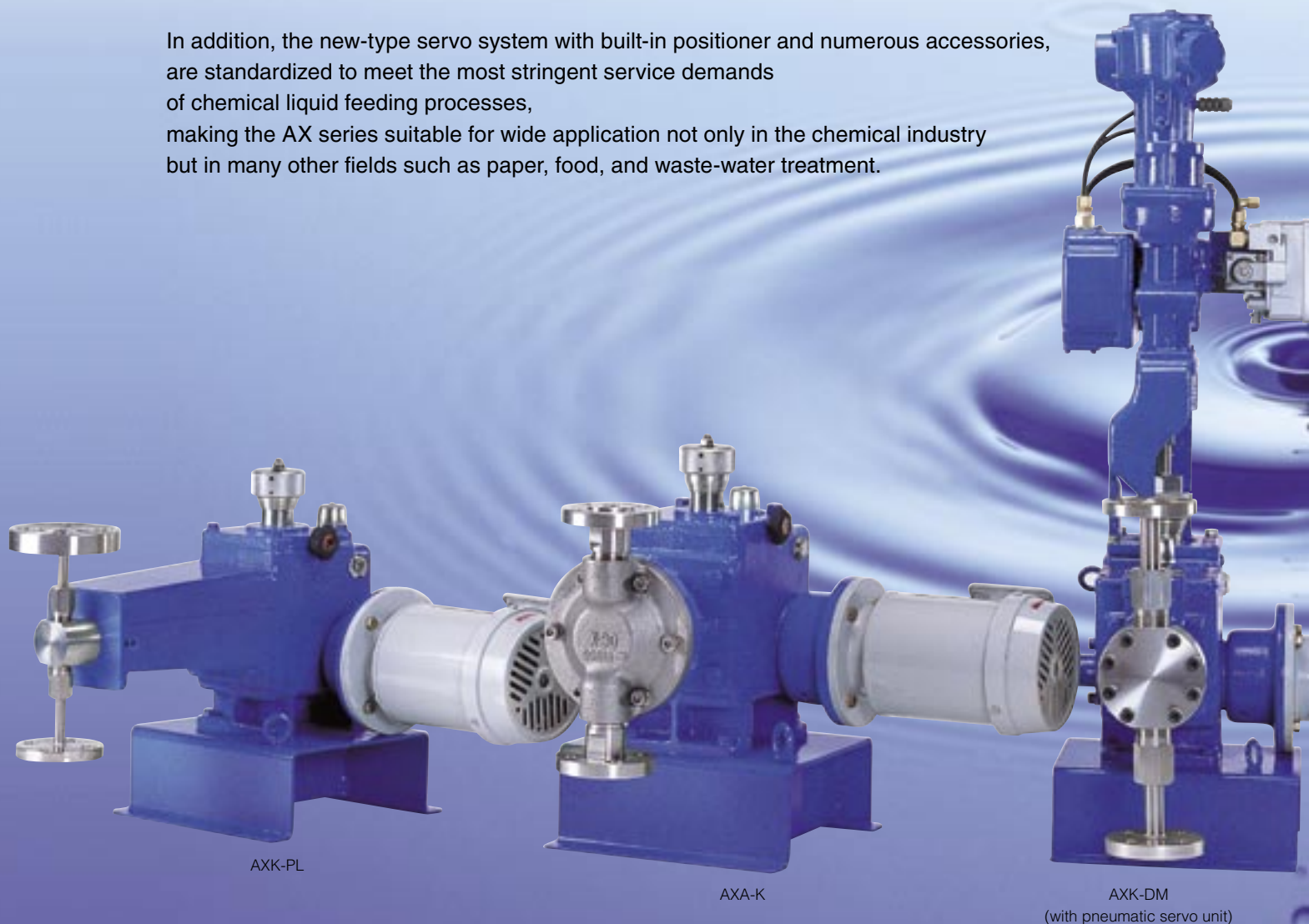

## High precision and reliability

Iwaki AX series are highly precise and reliable metering pumps for chemical processes which achieve metering accuracy within  $\pm 1\%$  (see Note 1), linearity within  $\pm 2\%$  (see Note 2) and repeatability within  $\pm 2\%$  (see Note 3).

## Improved cost performance

The mechanical efficiency of the reduction gear as well as that of the entire pump is improved. In addition, the employment of a large-capacity pump head and the standardization of high-speed types have further improved the cost efficiency of the pump.

# pump



AXA-DL  
(with electric servo unit)

AXJ-DL

3AXA-DL  
(3-heads type)

## Compact and lightweight

An integrated SL crank and worm reduction gear incorporated in the compact driving unit, reducing the pump installation area to a half or less as well as the overall weight to 2/3 or less.

## New integrated servo system with built-in positioner

An integrated servo unit with built-in positioner is employed, which directly controls the pump via mADC signal. This new type servo system has simplified both instrumentation work and also field adjustment.

Note 1: Metering accuracy expresses flow deviation from average rated capacity under steady state operating conditions, when the capacity is repeatedly measured.

Note 2: Linearity indicates the deviation of stroke/capacity ratio from the ideal straight line. Note that the linearity is not guaranteed.

Note 3: Repeatability describes the ability to reproduce a specific pump flow rate under a given set of conditions when capacity setting is varied. Note that the reproducibility is not guaranteed.

# Highly reliable advanced mechanism

## SL crank

(Screwed L crank patented in Japan and other countries)

The SL crank features a simple structure but is capable of generating a high piston driving force and features a highly reliable stroke adjustment mechanism for reciprocating pumps.

## High-strength, simplified structure

Compared with conventional cranks, eg. split cam and connecting rod, the SL crank features a solid cam and connecting rod, leading to considerably increased strength.

## No stroke length error

The cam is coupled to the crank via 10 or more screw threads. Owing to the wide area supporting the piston load, it is free from problems such as play and biting due to crank wear during long-term continuous operation.

## Compact and lightweight

A compact, lightweight driving unit has resulted from the reduced crank unit size.

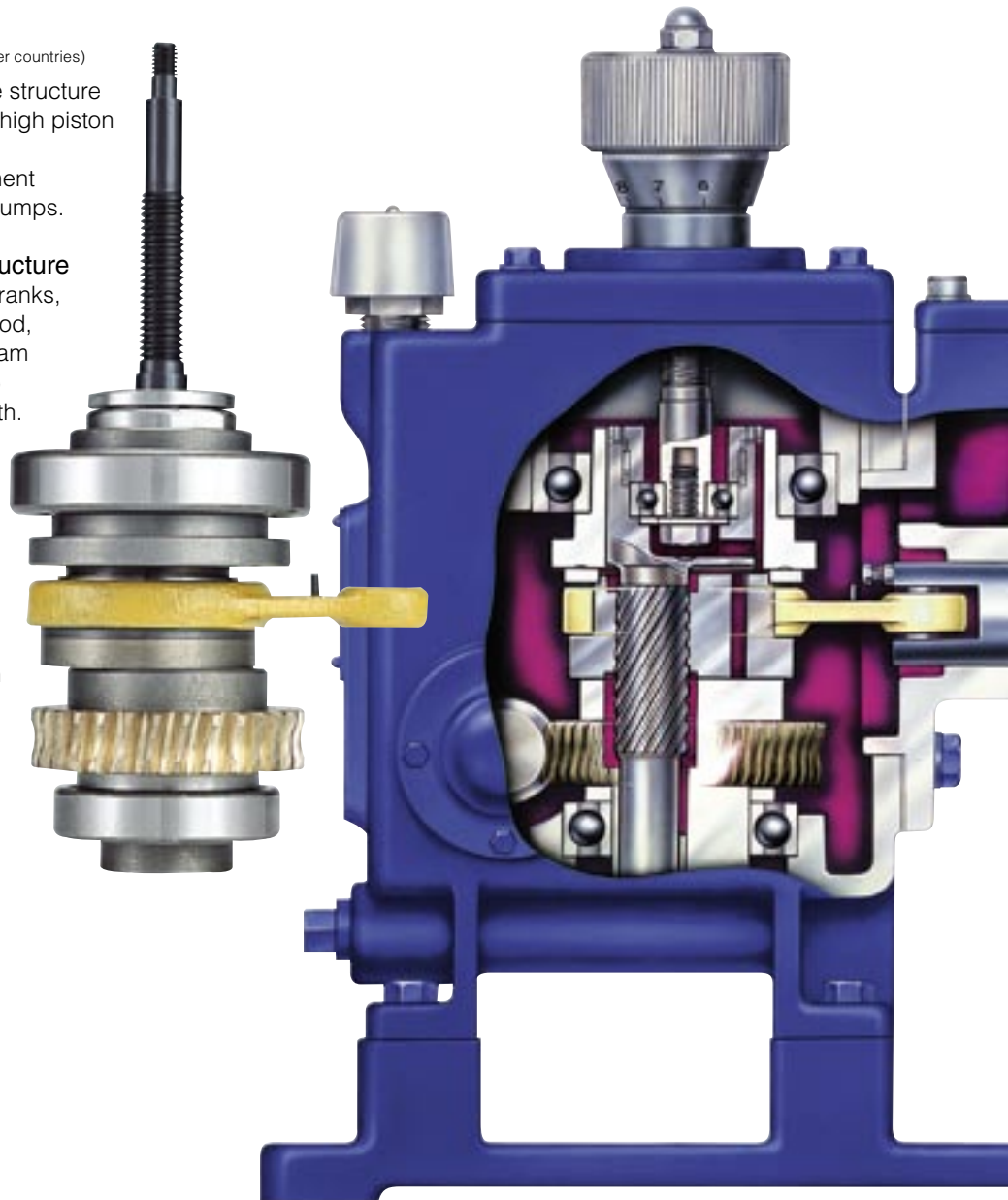

Hydraulic diaphragm

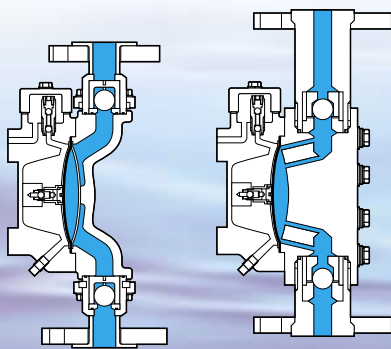

SUS

PVC

Plunger

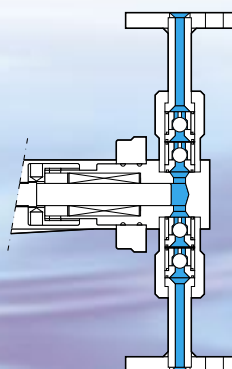

SUS

Mechanically-driven diaphragm

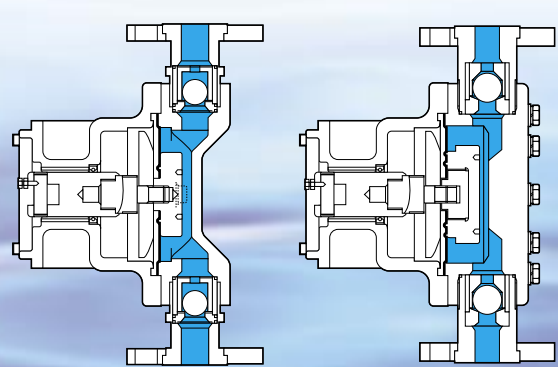

SUS

PVC

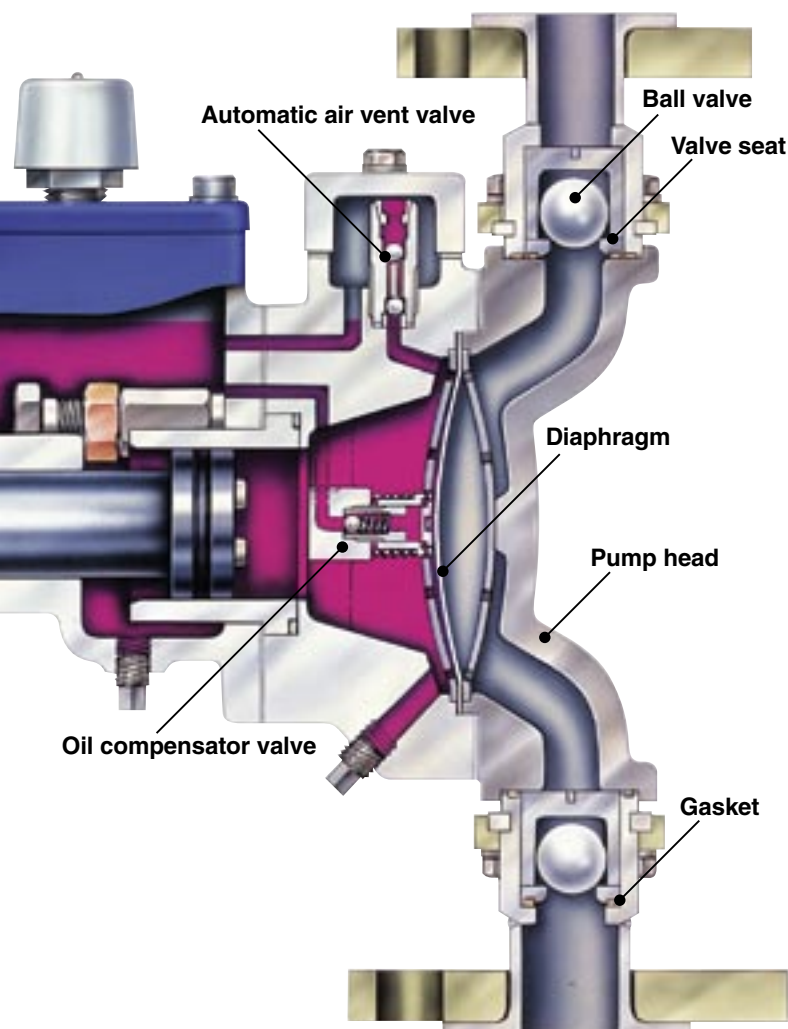

### Driving unit gear oil / hydraulic oil

Lubricating oil and hydraulic oil circuits are interconnected, and common oil is used. An air breather is mounted on the suction port to keep out rain water.

### Automatic air vent valve

This valve automatically discharges the gas contained in the hydraulic oil to prevent gas lock and maintain metering accuracy. The simple structure assuring correct operation, ensures the discharge of the gas contained in the hydraulic oil together with a small amount of oil at each stroke.

### Diaphragm

(Spherical diaphragm)

The spherical diaphragm developed by Iwaki operates under a unique principle, utilizing the change in material shape. No tensile stress acts on the diaphragm, assuring high durability under long-term continuous operation.



### Oil compensator valve

This is the valve to keep the oil volume of hydraulic cylinder at the optimum level. The mechanically-operated valve always opens at the bottom dead position of diaphragm to avoid excess replenishment of oil and diaphragm damage.

## Material of wet end parts

Type of pump	Hydraulic diaphragm		Plunger	Mechanically-driven diaphragm	
	SUS	PVC	SUS	SUS	PVC
<b>Pump head</b>	SUS316/SCS14	PVC	SUS316	SUS304/SCS13	PVC
<b>Ball valve</b>	HC/SUS316	HC/SUS316/CE	HC/SUS440C	SUS304	SUS304/CE
<b>Valve seat</b>	SUS316	PVC	SUS316/SUS316STL	SUS304	PVC
<b>Gasket</b>	PTFE	-	PTFE	PTFE	-
<b>O-ring</b>	-	EPDM/FKM	-	-	EPDM/FKM
<b>Diaphragm</b>	PTFE	PTFE	-	PTFE	PTFE
<b>Plunger</b>	-	-	SUS316+HCr/CE	-	-
<b>Others</b>	Cylinder head (not wet end) 1. Low pressure type: Cast iron 2. Medium pressure type: SCPH-2				

Note: This table shows standard material.  
Please refer "AX series metering pump technical information" for detail.

## Symbols

SCS13	Stainless steel (equivalent to SUS304)
SCS14	Stainless steel (equivalent to SUS316)
HC	Hastelloy C-276
440C	Stainless steel 440C
STL	Stellite alloy
HCr	Hard chrome plating
PVC	Non plasticized-polyvinyl chloride
PTFE	Polytetrafluoroethylene (Teflon® etc.)
EPDM	Ethylene-propylene rubber
FKM	Fluororubber
CE	Ceramic

# High performance hydraulic system

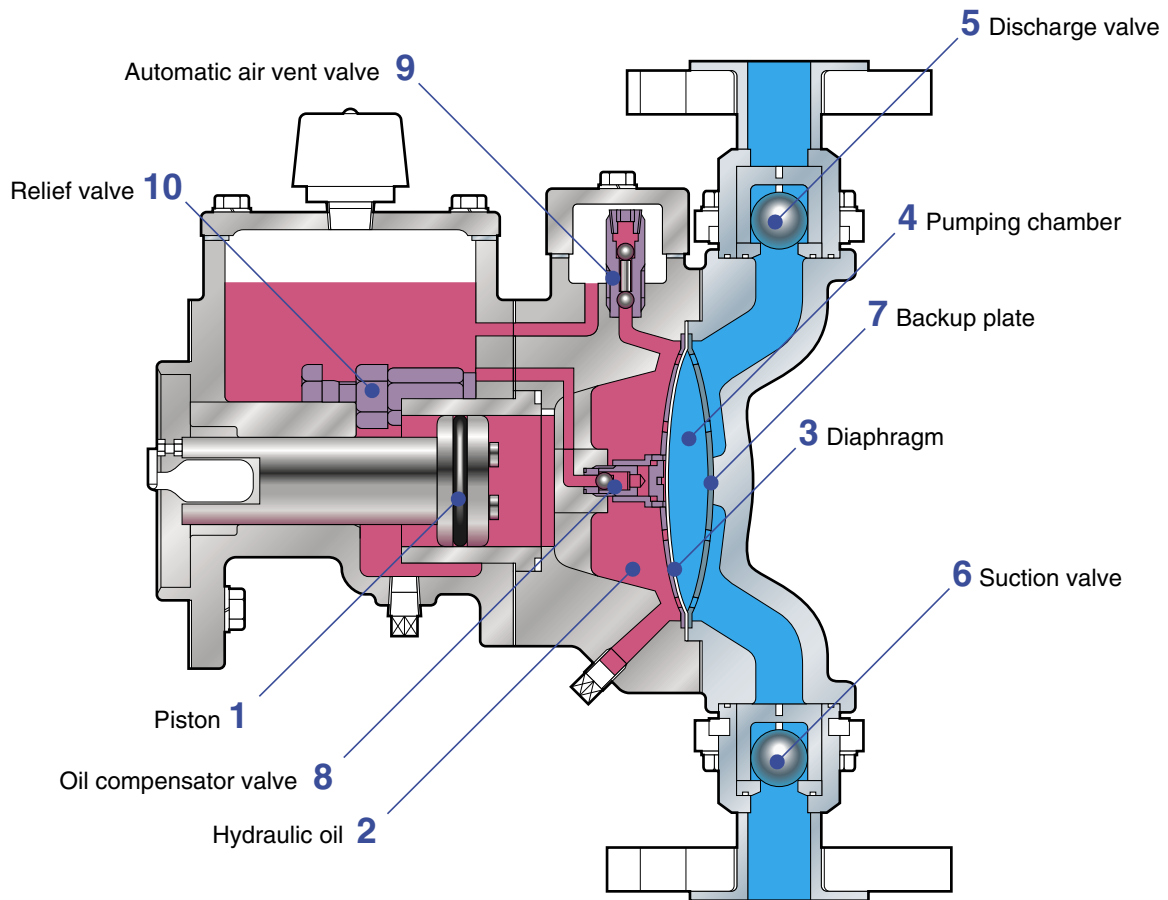

## Operating principle

When piston "1" advances, it moves diaphragm "3" through hydraulic oil "2" and pushes out the liquid in pumping chamber "4", which in turn opens discharge valve "5" and is discharged through the valve (discharge stroke). Conversely, when the piston retracts, the diaphragm is sucked back, and liquid opens suction valve "6" to enter the pump chamber (suction stroke). As a result, the diaphragm serves only as a membrane to separate hydraulic oil from liquid and suffers no stress concentration. Additionally, the diaphragm is protected by backup plate "7".

## Oil compensator valve

Oil compensator valve "8" automatically compensates for the shortage in hydraulic oil 2 to maintain the oil at the specified. Should oil shortage occur, the max. retract point (bottom dead center) of the diaphragm is shifted backward from the optimum position, causing the diaphragm to depress the oil compensator valve, open the valve port, and introduce oil into the oil cylinder. The oil compensator valve detects diaphragm position and replenish hydraulic oil thus making it possible to avoid excess oil replenishment and therefore optimum operation.

## Automatic air vent valve

Automatic air vent valve "9", a ball check valve with valve seat on both upper and lower sides, automatically discharges the gas generated and contained in the hydraulic oil. While the valve moves from the lower to the upper valve seat in the early stage of the suction stroke, air together with a small amount of oil is discharged within a short time period. The automatic air vent valve and hydraulic cylinder from an integrated unit to facilitate handling and maintenance.

\* Set spring pressure of the check valve (ball valve): 0.2 to 0.3 kgf/cm<sup>2</sup>.

## Relief valve

Built-in oil relief valve "10" protects the pump from abnormally high pressure on the process side and from misoperation of the discharge side valve.

# Wide variety of pump components

## Series configuration

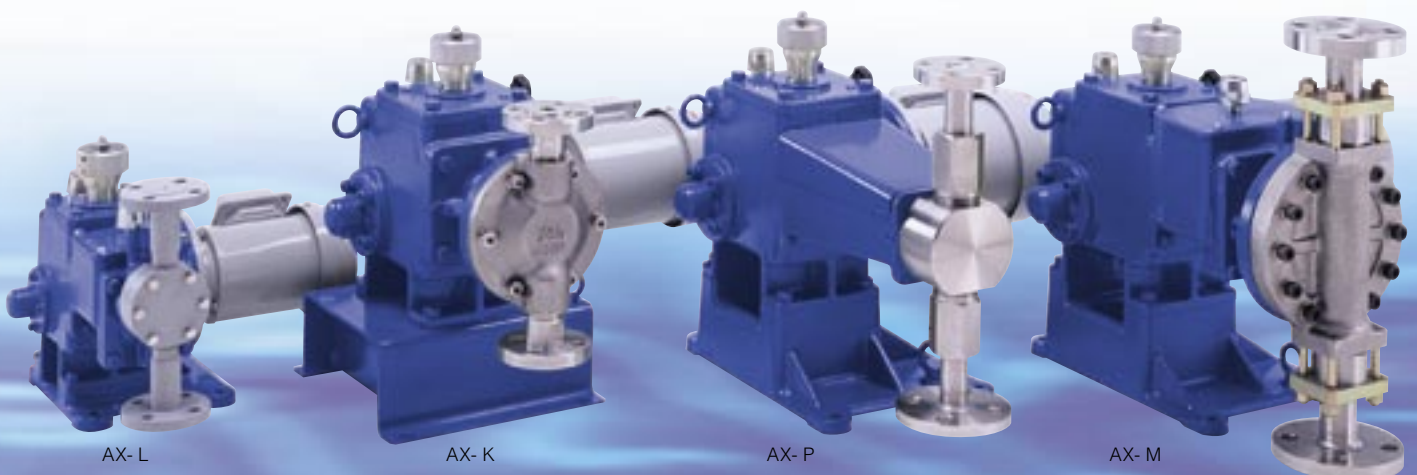
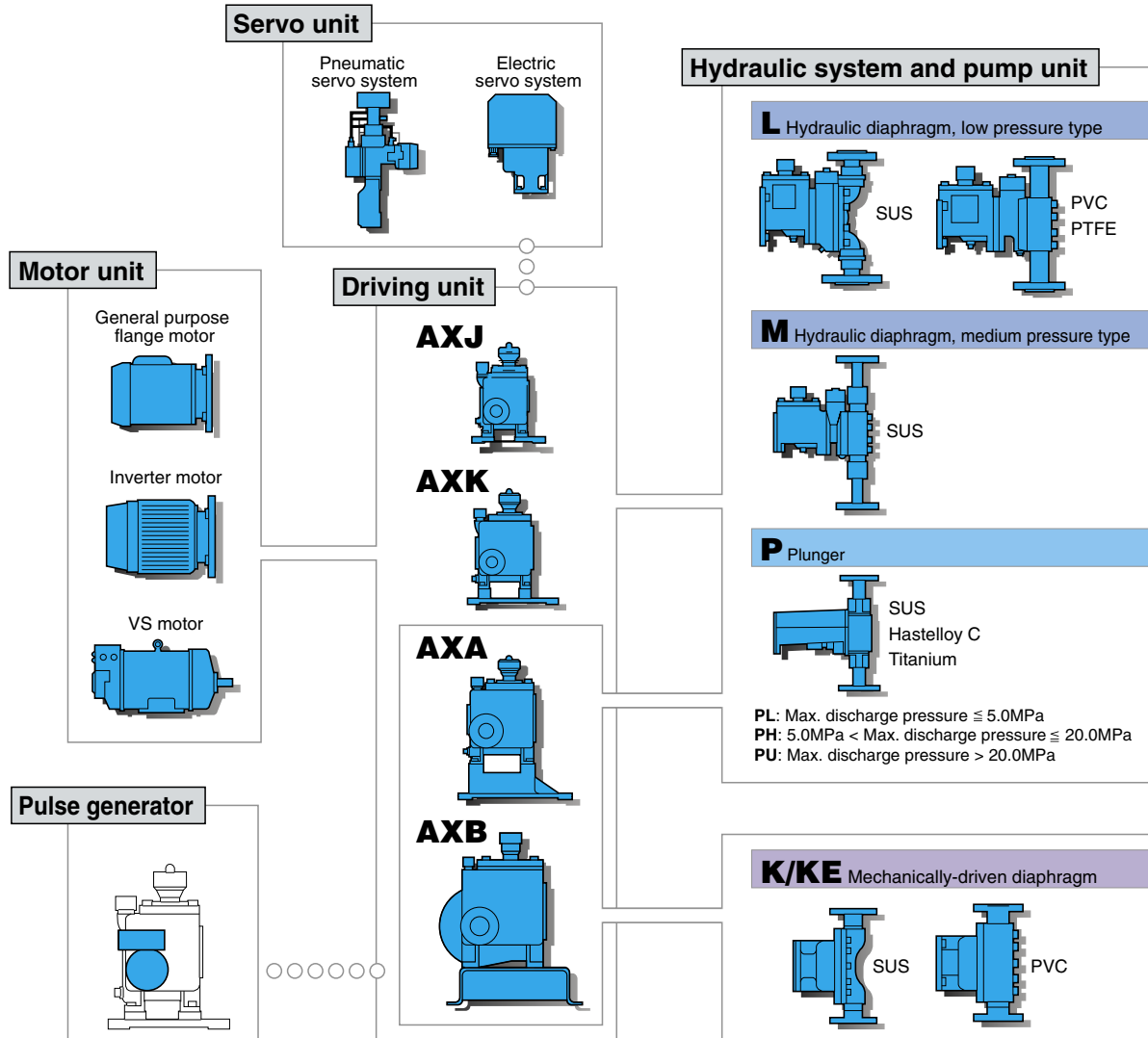

# Major standard specifications (Dimensions in mm)

## AX-L

Hydraulic diaphragm, Low pressure type

**AXJ** Stroke length : 0 to 15mm  
Standard motor : 0.2kW

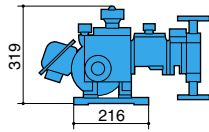

Piston diameter ø mm	Max. discharge flow L/min							Maximum discharge pressure MPa
	Number of strokes (spm) at 50Hz				Number of strokes (spm) at 60Hz			
	G: 48	W: 72	H: 96	R: 120	G: 58	W: 86	H: 116	
<b>7</b>	0.022	0.034	0.045	0.056	0.027	0.040	0.054	1.0
<b>11</b>	0.061	0.092	0.123	0.153	0.073	0.110	0.147	1.0
<b>15</b>	0.118	0.177	0.236	0.295	0.142	0.212	0.283	1.0
<b>22</b>	0.254	0.381	0.508	0.636	0.305	0.458	0.610	1.0
<b>30</b>	0.478	0.717	0.956	1.19	0.574	0.860	1.14	1.0
<b>42</b>	0.918	1.37	1.83	2.29	1.10	1.66	2.21	0.7

Note: The maximum discharge pressure in the table applies to stainless steel type.  
That for PVC type is 0.7MPa.

**AXK** Stroke length : 0 to 24mm  
Standard motor : 0.4/0.2kW

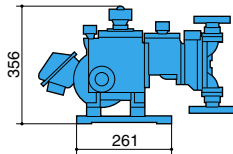

Piston diameter ø mm	Max. discharge flow L/min							Maximum discharge pressure MPa
	Number of strokes (spm) at 50Hz				Number of strokes (spm) at 60Hz			
	G: 48	W: 72	H: 96	R: 120	G: 58	W: 86	H: 116	
<b>30</b>	0.741	1.11	1.48	1.85	0.892	1.34	1.78	1.0
<b>42</b>	1.45	2.18	2.90	3.63	1.75	2.62	3.50	1.0
<b>52</b>	2.25	3.37	4.50	5.62	2.71	4.07	5.42	0.7
<b>68</b>	3.89	5.83	7.73	9.73	4.68	7.03	9.38	0.4

Note: The maximum discharge pressure in the table applies to stainless steel type.  
That for PVC type is 0.7MPa.

**AXA** Stroke length : 0 to 30mm  
Standard motor : 0.75/0.4kW

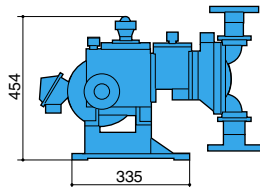

Piston diameter ø mm	Max. discharge flow L/min							Maximum discharge pressure MPa
	Number of strokes (spm) at 50Hz				Number of strokes (spm) at 60Hz			
	G: 48	W: 72	H: 96	R: 120	G: 58	W: 86	H: 116	
<b>42</b>	1.83	2.75	3.67	4.59	2.21	3.32	4.42	1.0
<b>52</b>	2.81	4.22	5.63	7.03	3.39	5.09	6.78	1.0
<b>68</b>	4.81	7.21	9.62	12.0	5.79	8.70	11.6	0.7 - 0.8
<b>85</b>	7.52	11.2	15.0	18.8	9.05	13.6	18.1	0.4 - 0.5
<b>100</b>	10.5	15.7	21.0	26.3	12.6	19.0	25.3	0.3

Note: The maximum discharge pressure in the table applies to stainless steel type.  
That for PVC type is 0.7MPa.

**AXB** Stroke length : 0 to 40mm  
Standard motor : 1.5/0.75kW

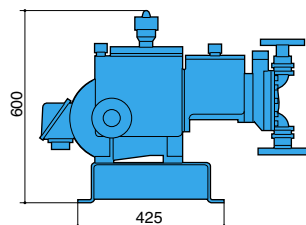

Piston diameter ø mm	Max. discharge flow L/min							Maximum discharge pressure MPa
	Number of strokes (spm) at 50Hz				Number of strokes (spm) at 60Hz			
	G: 48	W: 72	H: 96	R: 120	G: 58	W: 86	H: 116	
<b>52</b>	3.75	5.62	7.5	9.38	4.51	6.78	9.04	1.0
<b>68</b>	6.41	9.62	12.8	16.0	7.72	11.6	15.4	1.0
<b>85</b>	10.0	15.0	20.0	25.0	12.0	18.1	24.1	0.7 - 1.0
<b>100</b>	13.7	20.5	27.4	34.3	16.5	24.8	33.0	0.5 - 0.7
<b>122</b>	20.6	30.9	41.3	51.6	24.8	37.3	49.7	0.3 - 0.5

Note: The maximum discharge pressure in the table applies to stainless steel type.  
That for PVC type is 0.7MPa.

## AX-M

Hydraulic diaphragm, Medium pressure type

**AXJ** Stroke length : 0 to 15mm  
Standard motor : 0.2kW

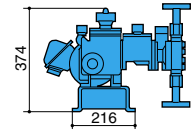

Piston diameter ø mm	Max. discharge flow L/min							Maximum discharge pressure MPa
	Number of strokes (spm) at 50Hz				Number of strokes (spm) at 60Hz			
	G: 48	W: 72	H: 96	R: 120	G: 58	W: 86	H: 116	
<b>11</b>	0.054	0.082	0.109	0.136	0.065	0.098	0.131	5.0
<b>15</b>	0.108	0.162	0.216	0.270	0.129	0.194	0.259	5.0
<b>22</b>	0.246	0.369	0.492	0.615	0.295	0.443	0.591	2.5
<b>30</b>	0.468	0.702	0.936	1.17	0.561	0.842	1.12	1.3

**AXK** Stroke length : 0 to 24mm  
Standard motor : 0.4kW

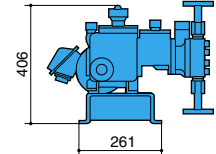

Piston diameter ø mm	Max. discharge flow L/min							Maximum discharge pressure MPa
	Number of strokes (spm) at 50Hz				Number of strokes (spm) at 60Hz			
	G: 48	W: 72	H: 96	R: 120	G: 58	W: 86	H: 116	
<b>22</b>	0.385	0.578	0.771	0.964	0.464	0.697	0.930	3.8
<b>30</b>	0.733	1.10	1.46	1.83	0.883	1.32	1.76	2.0

**AXA** Stroke length : 0 to 30mm  
Standard motor : 0.75kW

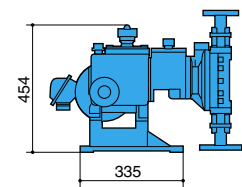

Piston diameter ø mm	Max. discharge flow L/min							Maximum discharge pressure MPa
	Number of strokes (spm) at 50Hz				Number of strokes (spm) at 60Hz			
	G: 48	W: 72	H: 96	R: 120	G: 58	W: 86	H: 116	
<b>30</b>	0.916	1.37	1.83	2.29	1.10	1.65	2.20	4.2 - 3.7
<b>42</b>	1.79	2.69	3.59	4.49	2.16	3.24	4.33	2.1-1.9
<b>52</b>	2.75	4.13	5.50	6.88	3.31	4.98	6.64	1.4 - 1.2

**AXB** Stroke length : 0 to 40mm  
Standard motor : 1.5kW

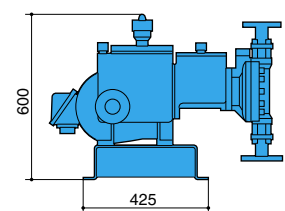

Piston diameter ø mm	Max. discharge flow L/min							Maximum discharge pressure MPa
	Number of strokes (spm) at 50Hz				Number of strokes (spm) at 60Hz			
	G: 48	W: 72	H: 96	R: 120	G: 58	W: 86	H: 116	
<b>42</b>	2.39	3.59	4.79	5.98	2.88	4.33	5.77	3.0 - 4.2
<b>52</b>	3.67	5.5	7.34	9.18	4.42	6.64	8.85	1.9 - 2.7
<b>68</b>	6.27	9.41	12.5	15.6	7.56	11.3	15.1	1.3 - 1.6

Note: The maximum discharge pressure in the table applies to stainless steel type.  
That for PVC type is 0.7MPa.



**AX-P**

Plunger

**AXJ** Stroke length : 0 to 15mm  
Standard motor : 0.2kW

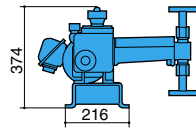

Plunger diameter ø mm	Max. discharge flow L/min						Maximum discharge pressure MPa	
	Number of strokes (spm) at 50Hz			Number of strokes (spm) at 60Hz				
	G: 48	W: 72	H: 96	R: 120	G: 58	W: 86		H: 116
<b>05</b>	0.012	0.019	0.025	0.031	0.015	0.023	0.030	10.0
<b>08</b>	0.032	0.048	0.065	0.081	0.039	0.058	0.078	19.4
<b>11</b>	0.062	0.093	0.124	0.155	0.074	0.112	0.149	10.3
<b>16</b>	0.137	0.206	0.275	0.343	0.165	0.247	0.330	4.8
<b>22</b>	0.260	0.390	0.520	0.650	0.312	0.468	0.624	2.5
<b>32</b>	0.550	0.825	1.10	1.37	0.660	0.990	1.32	1.2
<b>44</b>	1.01	1.52	2.03	2.54	1.22	1.84	2.45	0.6

**AX-K/KE**

Mechanically-driven diaphragm

**AXJ** Motor output : 0.4kW

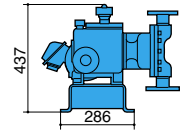

Model	Max. discharge flow L/min						Maximum discharge pressure MPa
	Number of strokes (spm) at 50Hz			Number of strokes (spm) at 60Hz			
	G: 48	W: 72	H: 96	G: 58	W: 86	H: 116	
<b>K90</b>	1.4	2.1	2.8	1.7	2.6	3.4	0.5
<b>K120</b>	3.5	5.3	7.1	4.3	6.4	8.6	0.3
<b>KE90</b>	1.1	1.7	-	1.4	2.1	-	0.2
<b>KE120</b>	2.9	4.4	-	3.5	5.3	-	0.3

Note: K is for standard. KE is for latex application.  
If flow rate (which you need) exceeds value on above table, CX series is available.  
Please refer CX series catalog.

**AXK** Stroke length : 0 to 24mm  
Standard motor : 0.4/0.2kW

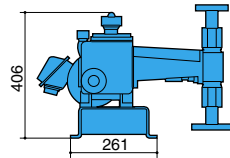

Plunger diameter ø mm	Max. discharge flow L/min						Maximum discharge pressure MPa	
	Number of strokes (spm) at 50Hz			Number of strokes (spm) at 60Hz				
	G: 48	W: 72	H: 96	R: 120	G: 58	W: 86		H: 116
<b>08</b>	0.051	0.076	0.102	0.127	0.061	0.092	0.123	29.2
<b>11</b>	0.097	0.146	0.195	0.243	0.117	0.176	0.235	15.4
<b>16</b>	0.215	0.323	0.431	0.538	0.259	0.389	0.519	7.3
<b>22</b>	0.407	0.611	0.814	1.01	0.490	0.736	0.982	3.8
<b>32</b>	0.861	1.29	1.72	2.15	1.03	1.55	2.07	1.8
<b>44</b>	1.62	2.44	3.25	4.07	1.96	2.94	3.92	0.9

**AXK** Motor output : 1.5/0.75kW

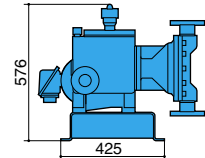

Model	Max. discharge flow L/min				Maximum discharge pressure MPa
	Number of strokes (spm) at 50Hz		Number of strokes (spm) at 60Hz		
	G: 48	W: 72	G: 58	W: 86	
<b>K150</b>	7.5	11.3	9.1	13.7	0.4
<b>K180</b>	12.4	18.6	15.0	22.5	0.3
<b>KE180</b>	11.0	16.5	13.2	19.9	0.3

Note: K is for standard. KE is for latex application.

**AXA** Stroke length : 0 to 30mm  
Standard motor : 0.75/0.4kW

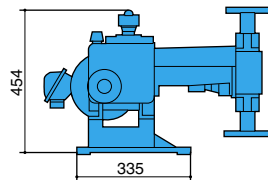

Plunger diameter ø mm	Max. discharge flow L/min						Maximum discharge pressure MPa	
	Number of strokes (spm) at 50Hz			Number of strokes (spm) at 60Hz				
	G: 48	W: 72	H: 96	R: 120	G: 58	W: 86		H: 116
<b>08</b>	0.063	0.095	0.127	0.159	0.076	0.115	0.153	34.3
<b>11</b>	0.120	0.180	0.241	0.301	0.145	0.218	0.290	26.8
<b>16</b>	0.260	0.391	0.521	0.652	0.314	0.471	0.628	12.6
<b>22</b>	0.498	0.747	0.997	1.24	0.600	0.901	1.20	6.7
<b>32</b>	1.07	1.61	2.15	2.69	1.29	1.94	2.59	3.1
<b>44</b>	2.03	3.05	4.07	5.09	2.45	3.68	4.90	1.6
<b>58</b>	3.53	5.30	7.07	8.84	4.26	6.40	8.53	0.9
<b>68</b>	4.86	7.29	9.72	12.1	5.85	8.79	11.7	0.6

**AXB** Stroke length : 0 to 40mm  
Standard motor : 1.5/0.75kW

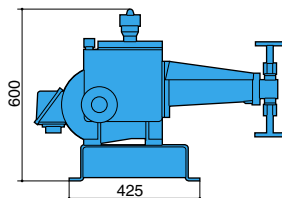

Plunger diameter ø mm	Max. discharge flow L/min						Maximum discharge pressure MPa	
	Number of strokes (spm) at 50Hz			Number of strokes (spm) at 60Hz				
	G: 48	W: 72	H: 96	R: 120	G: 58	W: 86		H: 116
<b>11</b>	0.16	0.241	0.321	0.401	0.193	0.29	0.387	35.0
<b>16</b>	0.347	0.521	0.695	0.869	0.418	0.628	0.838	19.5
<b>22</b>	0.664	0.996	1.32	1.66	0.8	1.2	1.6	10.5
<b>32</b>	1.43	2.15	2.87	3.58	1.72	2.59	3.46	4.8
<b>44</b>	2.71	4.07	5.43	6.78	3.27	4.91	6.54	2.5
<b>58</b>	4.71	7.07	9.43	11.7	5.67	8.52	11.3	1.4
<b>68</b>	6.48	9.72	12.9	16.2	7.8	11.7	15.6	1.1
<b>88</b>	10.8	16.2	21.7	27.1	13.0	19.6	26.1	0.6

# Feature for process automation and FA

## Electric servo unit

The servo unit for the AX series features a built-in positioner, which directly controls the pump stroke length by mADC signal from the controller. In addition, a special stroke controller the "Iwaki Stroke Setter" with ratio relay, signal limiter, and other control functions has been designed to meet automatic control requirements in a variety of fields. This system with the simple structure facilitates both instrumentation work as well as adjustment.

### Direct control by mADC signal

This servo unit directly controls pump discharge within a range from 0 to 100% by 4 to 20mA signal from the automatic controller (refer to Fig. 2).

### Simplified electrical and instrumentation work

This servo unit requires no wiring for the servo motor and feedback resistor which, on conventional servo systems, is indispensable. Only mADC signal wiring is required, which not only improves ease of instrumentation work but also allows control which is highly resistant to the externally induced noise (refer to Fig. 3).

### Simplified system adjustment

The pump side servo unit is adjustment prior to delivery. Unlike conventional systems, field adjustment between servo unit and positioner is unnecessary.

### Simplified structure

The system can be constructed with a minimum number of control devices (refer to Fig. 4).



### AX servo unit (with built-in positioner)

Input signal	4–20mA DC (corresponding to 0 to 100% stroke length)
Output signal	4–20mA DC (for stroke length indication and operation)
Devices	Fully electronic positioner, servo motor, potentiometer, limit switch
Power supply	100V ±10% AC, single-phase, 50/60Hz; other voltage types available
Structure	Totally enclosed outdoor type

### IWAKI stroke setter type (Stroke length indication controller)

Input signal	4–20mA DC or 1 to 5V DC
Output signal	4–20mA DC
Control functions	Ratio relay, signal limiter, zero shift, reverse operation, manual signal oscillator
Indication	(Change over type) digital indicator for stroke length, input signal, and output signal
Power supply	100–115V or 200 to 240V ±10% AC, single-phase, 50/60Hz
Structure and dimensions	Panel flush mounting type, 92 square X 165

## Speed controller

With the pump speed controller, the discharge flow of metering pumps AX series can be linearly controlled. Flow rate control by speed controller has the advantages of fast response and wide control range and has become more common with the widespread use of inverters.

The pulse generator detects the gear speed through a high frequency pulse generating proximity switch and outputs a digital pulse. The gear is directly coupled with the motor via the worm shaft, not only making it possible to obtain a correct speed signal but also allowing adaption to any variable speed motor.

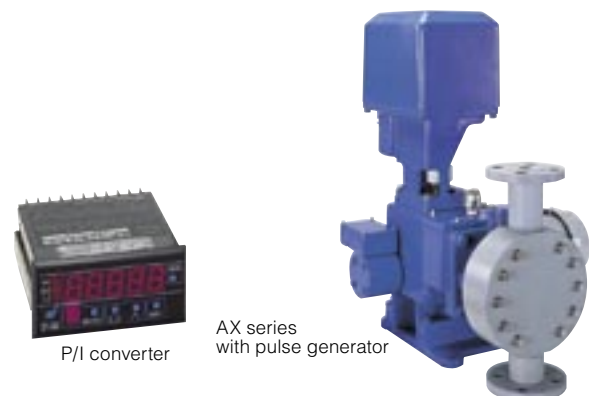

### Pulse generator (Speed signal generator)

Pulse generator	Output	1 pulse per revolution or 1 pulse per stroke Open collector output (maximum load current; 100mA)
	Power supply	10-30 VDC, current consumption of the generator main body: 20mA
P/I converter	Output	4–20mA DC, with power output for pulse generator
	Indication	Digital speed indicator
	Power supply	100V ±10% AC, single-phase, 50/60Hz; other voltage types available

• Pulse frequency: Maximum 240Hz (at motor maximum speed of 1,800 rpm)

## Pneumatic servo unit

The pneumatic servo unit for AX series employs a high torque pneumatic motor (piston type), and gives high reliability. Both pneumatic-pneumatic positioner, and also electric-pneumatic positioner which is operated by mADC input signal are available.

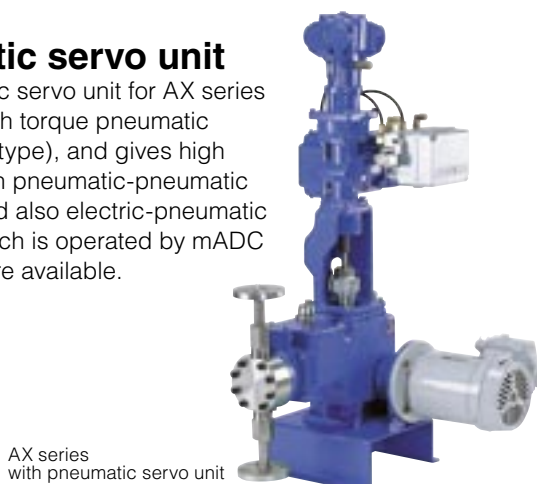

Input signal	Pneumatic-pneumatic positioner	0.02-0.1MPa
	Electric-pneumatic positioner	DC4-20mA (Input resistance 230) Note: 1
Air supply	Pressure	Standard: 0.3MPa, Max: 0.6MPa
	Air consumption	Normal: 30NL/min or less, Max: 100NL/min or less
Operating time		20 seconds (stroke length 0–100%)
Accuracy	Pneumatic-pneumatic positioner	±3% F.S Note: 2
	Electric-pneumatic positioner	±2.5% F.S

Note: 1. Explosion proof construction of electric-pneumatic positioner type is class d2G4.  
2. F.S means full scale.

## Automatic control system

Fig. 1

### Structural drawing of electric servo unit

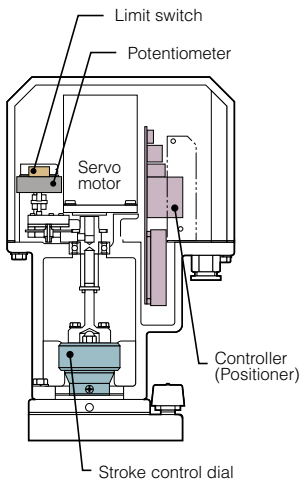

Fig. 2

### Example of direct control

Pump discharge can be directly controlled by output signal from the controller or ratio relay.

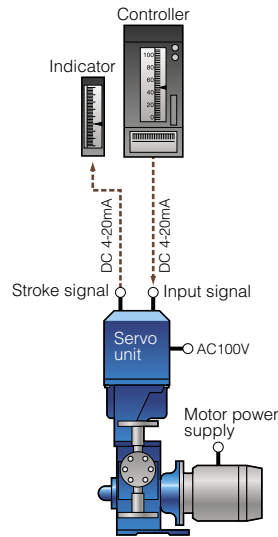

Fig. 3

### Combination with stroke setter

When the stroke setter is installed, ratio relay, signal limiter, zero shift, and other control functions as well as manual operation become available.

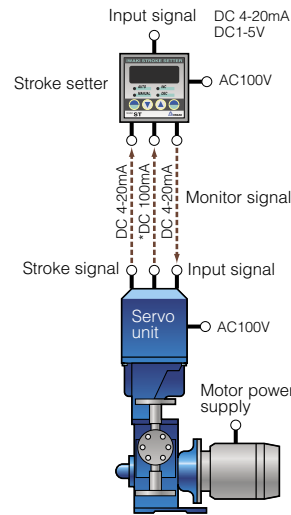

Fig. 4

### Example of two-value control (stroke length and speed)

An example of two-value separate control where speed is first controlled and then stroke length. Speed signal is output from the built-in pulse generator.

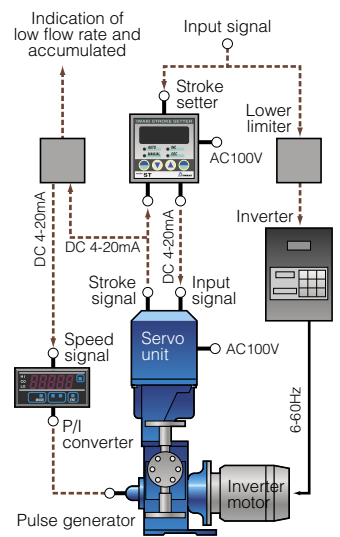

Fig. 5

### Speed feedback in inverter control

This type of control not only ensures accurate speed information but also features high response and a wide control range.

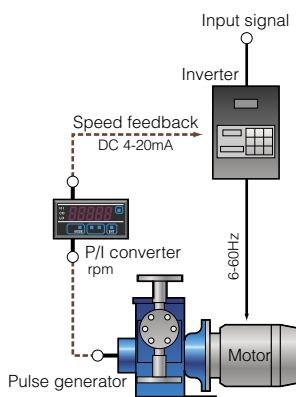

Fig. 6

### Example application to batch metering and charging

Controlling the accumulated number of pump strokes enables batch metering and charging.

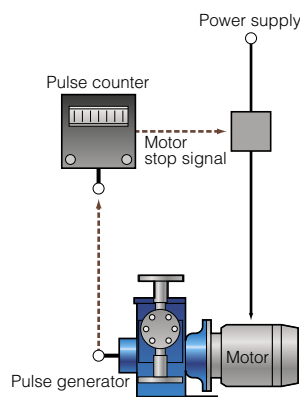

Fig. 7

### Pneumatic servo "A" type (Pneumatic-pneumatic positioner)

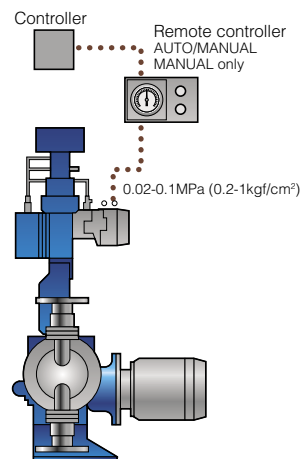
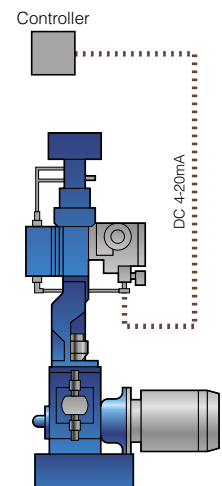

Fig. 8

### Pneumatic servo "D" type (Electro-pneumatic positioner)



## Optional accessories

Relief valve, back pressure valve, air chamber, and other standard equipment necessary for the metering pump piping are optionally available. Optional accessories of various standard materials (SUS316, PVC, PVDF fluororesin) are available.

### Flow checker (Flow detector)

- Capacity: 0.01–6L/min
- Working pressure: Max. 0.5MPa
- Material: PVC



### Relief valve

- Capacity: 1–70L/min
- Working pressure: 0.15–1MPa Note: High pressure types are also available.
- Material: SUS316, PVC, PVDF

### Diaphragm rupture detector

Diaphragm breakage monitor for double diaphragm type pumps. In the case of damage to the diaphragm, the monitor detects the difference of conductivity between hydraulic oil and process liquid and outputs an alarm signal. Its application range includes not only acids and alkalis but also organic solvents with low conductivity.



### Air chamber

- Capacity: 1–30 liters
- Working pressure: Max. 0.9MPa (SUS)  
: Max. 0.5MPa (PVC)
- Material: SUS316, PVC

Note: Accumulators (Bladder type) are also available.

### Back pressure valve

- Capacity: 1–70L/min
- Working pressure: 0.05–0.8MPa
- Material: SUS316, PVC, PVDF



PVC, 1 type

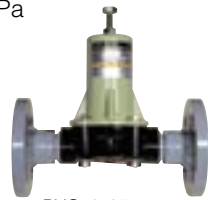

PVC, 3-25 type



PVC, N type



SUS, 2-25 type

[www.iwakipumps.jp](http://www.iwakipumps.jp)

IWAKI CO.,LTD. 6-6 Kanda-Sudacho 2-chome Chiyoda-ku Tokyo 101-8558 Japan TEL : (81)3 3254 2935 FAX : 3 3252 8892

#### EUROPE / U.S.A.

European office : IWAKI Europe GmbH	TEL: (49)2154 9254 0	FAX: 2154 9254 48
Austria : IWAKI (Austria) GmbH	TEL: (41)26 674 93 00	FAX: 26 674 93 02
Belgium : IWAKI Belgium N.V.	TEL: (32)13 67 02 00	FAX: 13 67 20 30
Denmark : IWAKI Nordic A/S	TEL: (45)48 24 2345	FAX: 48 24 2346
Finland : IWAKI Suomi Oy	TEL: (358)9 2745810	FAX: 9 2742715
France : IWAKI France S.A.	TEL: (33)1 69 63 33 70	FAX: 1 64 49 92 73
Germany : IWAKI Europe GmbH	TEL: (49)2154 9254 50	FAX: 2154 9254 55
Holland : IWAKI Holland B.V.	TEL: (31)297 241121	FAX: 297 273902
Italy : IWAKI Italia S.R.L.	TEL: (39)02 990 3931	FAX: 02 990 42888
Norway : IWAKI Norge AS	TEL: (47)66 81 16 60	FAX: 66 81 16 61
Spain : IWAKI Iberica Pumps, S.A.	TEL: (34)943 630030	FAX: 943 628799
Sweden : IWAKI Sverige AB	TEL: (46)8 511 72900	FAX: 8 511 72922
Switzerland : IWAKI (Schweiz) AG	TEL: (41)26 674 93 00	FAX: 26 674 93 02
U.K. : IWAKI Pumps (UK) Ltd.	TEL: (44)1743 231363	FAX: 1743 366507
U.S.A. : IWAKI America Inc.	TEL: (1)508 429 1440	FAX: 508 429 1386

#### ASIA / OCEANIA

Australia : IWAKI Pumps Australia Pty Ltd.	TEL: (61)2 9899 2411	FAX: 2 9899 2421
China		
Hong Kong : IWAKI Pumps Co., Ltd.	TEL: (852)2607 1168	FAX: 2607 1000
Shanghai : IWAKI Pumps (Shanghai) Co., Ltd.	TEL: (86)21 6272 7502	FAX: 21 6272 6929
Guangzhou : GFTZ IWAKI Engineering & Trading Co., Ltd.	TEL: (86)20 8435 0603	FAX: 20 8435 9181
Beijing : GFTZ Iwaki Engineering & Trading Co., Ltd. (Beijing office)	TEL: (86)10 6442 7713	FAX: 10 6442 7712
Korea : IWAKI Korea Co.,Ltd.	TEL: (82)2 2630 4800	FAX: 2 2630 4801
Malaysia : IWAKIm Sdn. Bhd.	TEL: (60)3 7803 8807	FAX: 3 7803 4800
Singapore : IWAKI Singapore Pte Ltd.	TEL: (65)6316 2028	FAX: 6316 3221
Indonesia : IWAKI Singapore (Indonesia Branch)	TEL: (62)21 6906606	FAX: 21 6906612
Taiwan : IWAKI Pumps Taiwan Co., Ltd.	TEL: (886)2 8227 6900	FAX: 2 8227 6818
Thailand : IWAKI (Thailand) Co.,Ltd.	TEL: (66)2 322 2471	FAX: 2 322 2477
Vietnam : IWAKI Pumps Vietnam Co., Ltd.	TEL: (84)613 933456	FAX: 613 933399

( )Country codes

**⚠ Caution for safety use:** Before use of pump, read instruction manual carefully to use the product correctly. Actual pumps may differ from the photos. Specifications and dimensions are subject to change without prior notice. For further details please contact us.

**⚠ Legal attention related to export.**

Our products and/or parts of products fall in the category of goods contained in the Export Trade Control Order Attachment List 1 of Japanese export control regulations, which includes complementary export control items. Please be reminded that export license, which is issued by the Ministry of Economy, Trade, and Industry in Japan could be required when products are exported from Japan.